

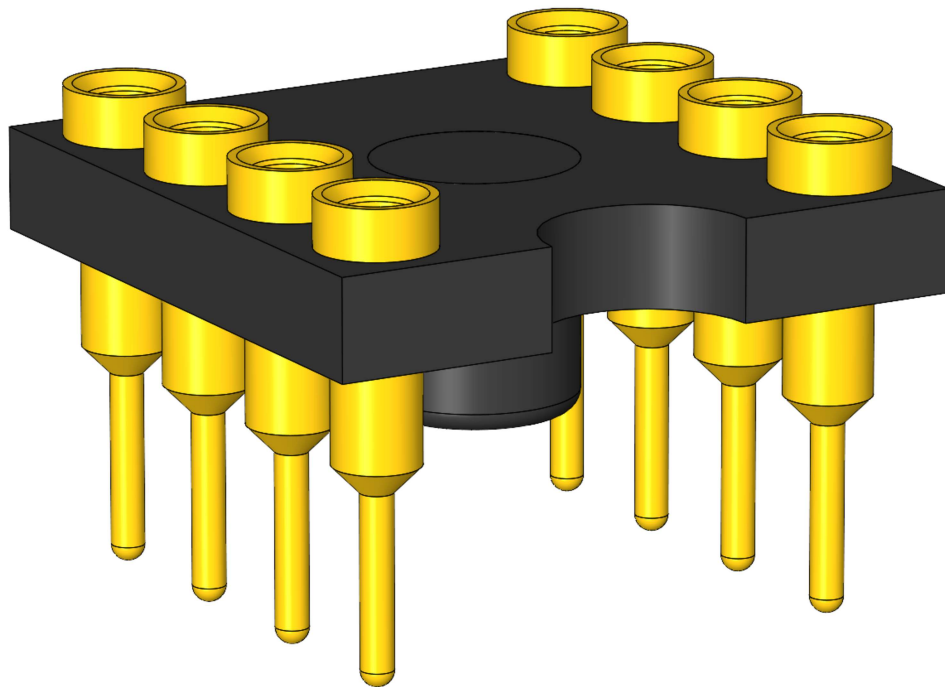

***High-Reliability Optoelectronic Sensor
Sockets for 3SP Technologies***

3SP Technologies
Source of Smart Solutions



Featuring Andon's Unique SenstacTM Contact

3SP TECHNOLOGIES						
3SP TECHNOLOGIES Part Number	Andon Part Number Replace "XXX" With terminal Type	Terminal Type		Pin Ø [in]	Page Number	Figure Number
		Thru-Hole	Surface Mount			
1948RxB	(2) C10-007-07-01-XXX-R27-L14	01P28	93P28	0.020	1	1
1064CHP	(2) C10-007-07-01-XXX-R27-L14	01P28	93P28	0.020	1	1
1999PLU	406-308-XXX-P15-H10	01S	93S	0.018	1	2
1999UMM	(2) 405-03-XXX-R27-L14	01S	93S	0.018	1	3
1999CMB	(2) C10-007-07-01-XXX-R27-L14	01P28	93P28	0.020	1	1
1999CHB	(2) C10-007-07-01-XXX-R27-L14	01P28	93P28	0.020	1	1
1999CVB	(2) C10-007-07-01-XXX-R27-L14	01P28	93P28	0.020	1	1
1999CMX	(2) 301-005-XXX-P26-S10	01S	93S	0.018	1	4
1999CHX	(2) 301-005-XXX-P26-S10	01S	93S	0.018	1	4
1999CVX	(2) 301-005-XXX-P26-S10	01S	93S	0.018	1	4
1999SHX	(2) 301-005-XXX-P26-S10	01S	93S	0.018	1	4

Heat sink socket available to reduce heat and noise. Contact Andon for details.

3SP TECHNOLOGIES

Top View Shown

Units: in [mm]

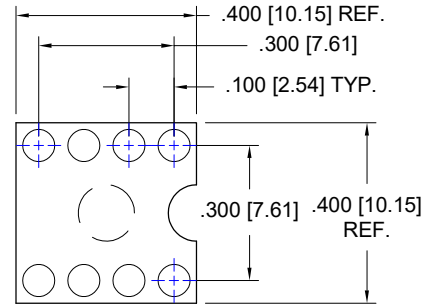
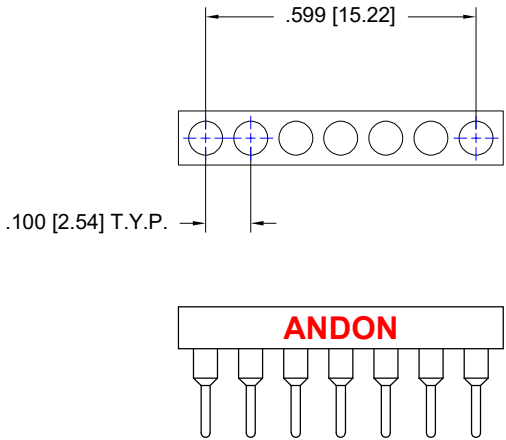

Thru-Hole: C10-007-07-01-01P28-R27-L14
Surface Mount: C10-007-07-01-93P28-R27-L14

Thru-Hole: 406-308-01S-P15-H10
Surface Mount: 406-308-93S-P15-H10

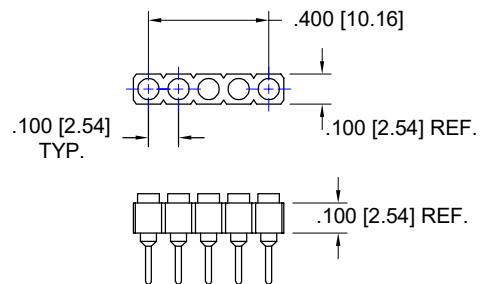
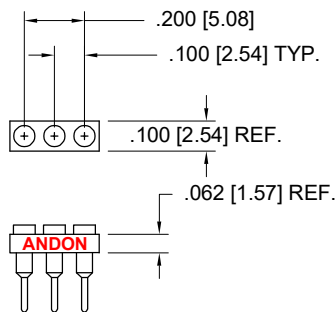

Thru-Hole: 405-03-01S-R27-L14
Surface Mount: 405-03-93S-R27-L14

Thru-Hole: 301-005-01S-P26-S10
Surface Mount: 301-005-93S-P26-S10

Cross Section Shown
Units: in [mm]

THRU HOLE OPTION

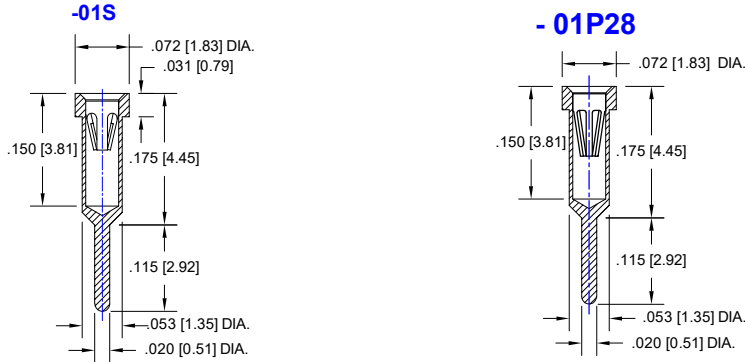

SURFACE MOUNT OPTION

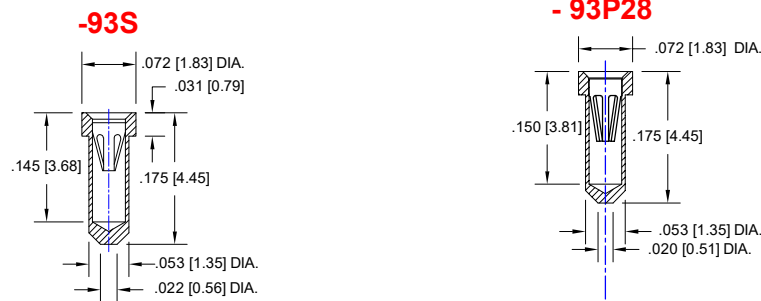

Material:

Insulator: Hi-Temp UL 94V-0
Terminal: Brass, per ASTM-B16
Contact: BeCu, Per ASTM-B194

Plating: RoHS COMPLIANT
R27 TERMINAL: GOLD / CONTACT: GOLD
OTHER PLATINGS AVAILABLE

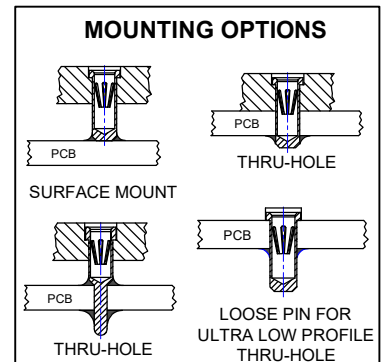

Terminal Acceptance and Forces							
Thru Hole Socket Terminals				Surface Mount Socket Terminals			
Thru Hole Terminal	Accepts Pin Diameter	Insertion Force	Withdrawal Force	Surface Mount Terminal	Accepts Pin Diameter	Insertion Force	Withdrawal Force
-01P28	Ø.028 [Ø0.71]	.70 oz Max	0.35 oz Min	-93P28	Ø.028 [Ø0.71]	.70 oz Max	0.35 oz Min
-01S	Ø.018 [Ø0.46]	9.0 oz Avg.	2.0 oz Min	-93S	Ø.018 [Ø0.46]	9.0 oz Avg.	2.0 oz Min

©Copyright 2026 Andon Electronics Corporation. All Rights Reserved. This material is protected under US and other copyrights and may not be copied, sold, or redistributed in any form without written permission of Andon Electronics Corporation. Copyrights and trademarks are property of their respective companies. We reserve the right to change specifications without notice. Andon makes no warranty, expressed or implied, as to the suitability of the sockets for the intended purpose.

Andon Proprietary Information
RoHS Compliant

*Sockets are not drawn to scale **3SP TECHNOLOGIES** 05/13/2026

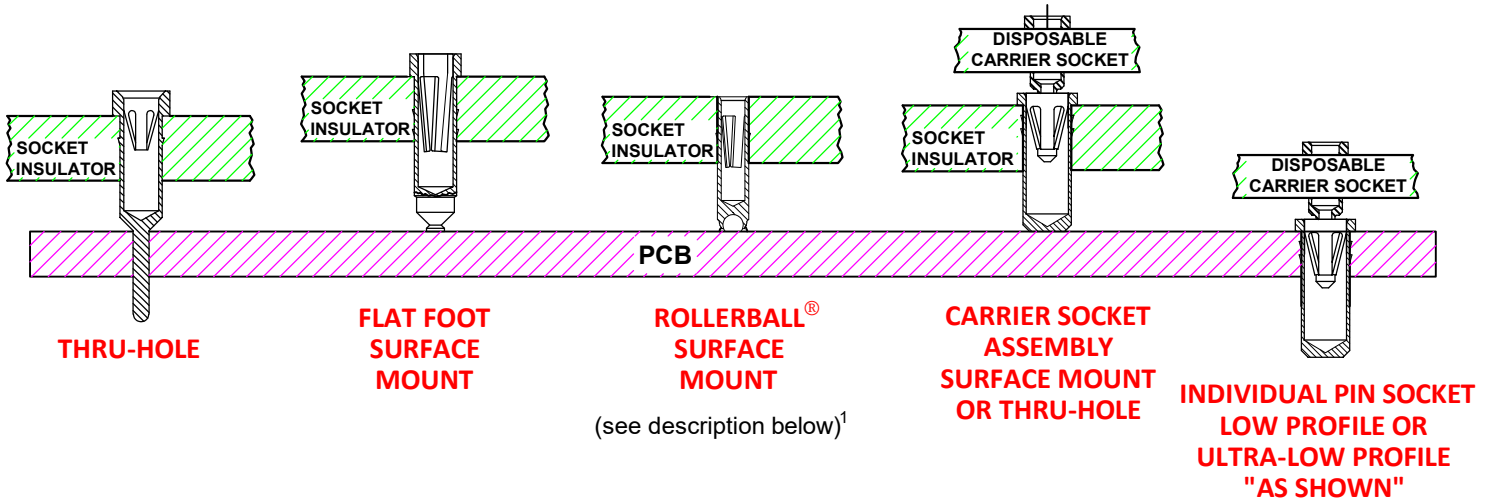

¹Andon's patented Rollerball[®] socket terminal option provides more accurate soldering, a stronger connection, and improved electrical connectivity - especially under shock and vibration - than other solder ball terminal designs. Better yet, it can enable you to avoid expensive rework and scrap - especially with larger PCBs where coplanarity is an inherent challenge.

The bottom of these terminals has a radiused hole, to prevent gas entrapment. The terminal is crimped over the solder ball beyond its hemisphere, encapsulating it - leaving just enough of the solder ball exposed to provide sufficient solder without the solder bridging common in conventional solder ball terminal designs.

With this unique design, the critical distance between the terminal and the PC board pad is typically reduced from .036"-.040" to .018"-.022". As such, the solder becomes part of the "anchor" cross-section - providing additional mechanical strength to the connection, as well as improved electrical connectivity. Because it also provides controlled dispersion of solder, this encapsulated solder ball reduces the risk of solder bridging inherent in conventional solder ball terminal designs.

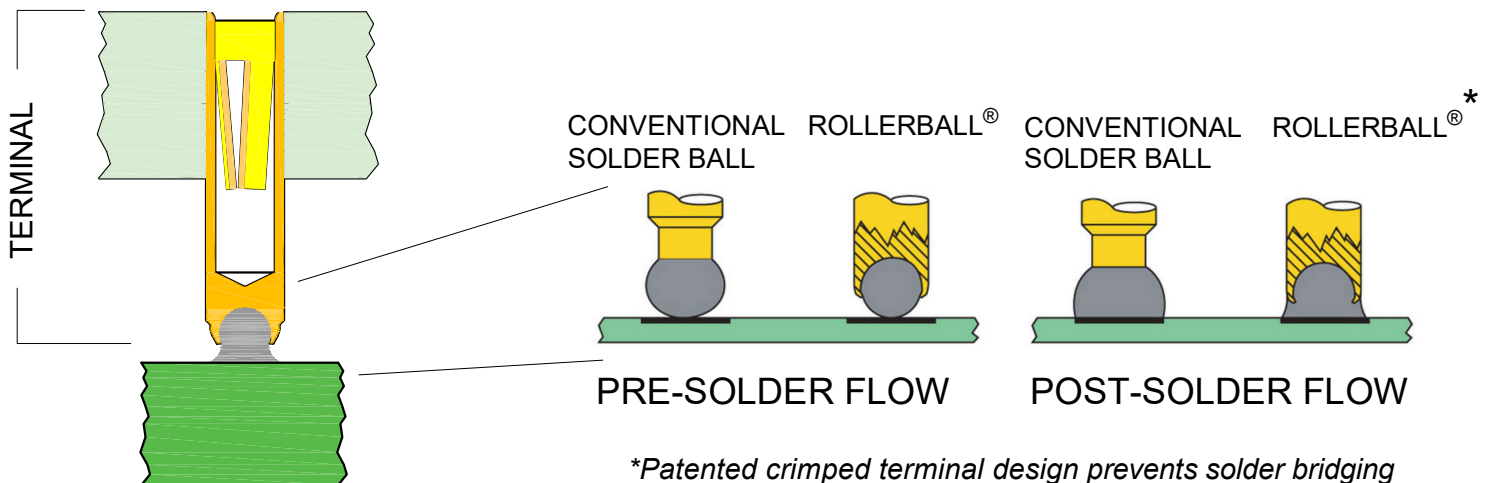

For fast, accurate placement of SIP sockets and ultra-low profile terminals

Phase 1:
Receive Carrier Assemblies designed to your pin layout.



Phase 2:
Place carrier assemblies onto PCB; run through your soldering process.



Phase 3:
Remove carrier and plug in your device; discard carrier or send back to our factory for reloading.

DIP

Before Soldering

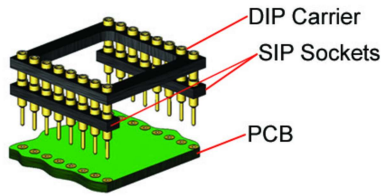

During Soldering

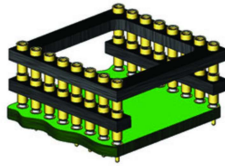

After Soldering

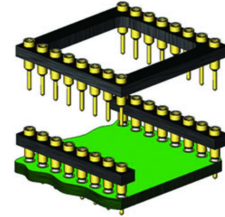

ULTRA-LOW PROFILE SIP

Before Soldering

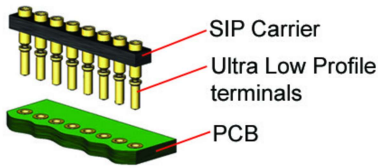

During Soldering

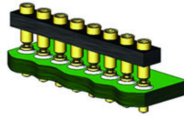

After Soldering

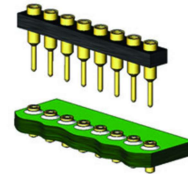

ULTRA-LOW PROFILE PGA

Before Soldering

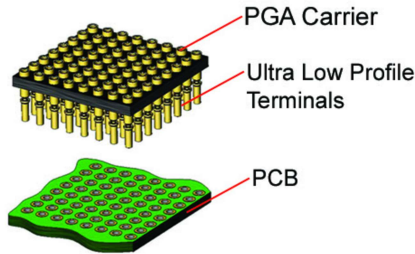

During Soldering

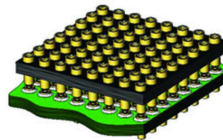

After Soldering

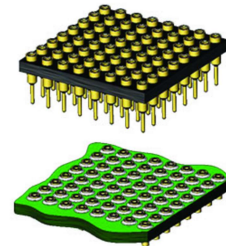

ULTRA LOW PROFILE DIP

Before Soldering

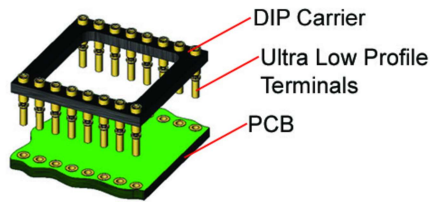

During Soldering

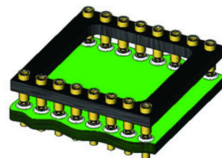

After Soldering

