

CRYSTEK CORPORATION						
CRYSTEK CORPORATION Model Number	Andon Part Number Replace "XXX" with Terminal Type	Terminal Type		Pin Ø [in]	Figure Number	Page Number
		Thru-Hole	Surface Mount			
CPLL66-1600-2200	680-22SP-SM-G10-L14-X	-	-	-	1	2
CLL58PLL	680-20SP-SM-G10-L14-X	-	-	-	2	2
CVCO38	605-12A-SM-G10-L14-X	-	-	-	3	2
CVCO55	605-16-SM-G10-L14-X	-	-	-	4	3
CVCO45	605-16-SM-G10-L14-X	-	-	-	4	3
CVCO38	605-16-SM-G10-L14-X	-	-	-	4	3
CVCO33	605-16-SM-G10-L14-X	-	-	-	4	3
CVCO25	605-16-SM-G10-L14-X	-	-	-	4	3
CVCOT8	605-16-SM-G10-L14-X	-	-	-	4	3
CVCO57P	605-16-SM-G10-L14-X	-	-	-	4	3
CVCO45 SERIES	612D-04-SM-G10-L14-X	-	-	-	5	3
CVPD-034	605D-06B-SM-G10-L14-X	-	-	-	6	3
CVXO-18T	605D-06B-SM-G10-L14-X	-	-	-	6	3
CVXO-016T	605D-06B-SM-G10-L14-X	-	-	-	6	3
CCPD-034	605D-06B-SM-G10-L14-X	-	-	-	6	3
CCPD-023	605D-06B-SM-G10-L14-X	-	-	-	6	3
CCLD-023	605D-06B-SM-G10-L14-X	-	-	-	6	3
CVHD-037X	605D-06B-SM-G10-L14-X	-	-	-	6	3
CVPD-037X	605D-06B-SM-G10-L14-X	-	-	-	6	3
CCSO-914X-245.760	606D-04B-SM-G10-L14-X	-	-	-	7	4
CCSO-914X3-1000	606D-04B-SM-G10-L14-X	-	-	-	7	4
CCSO-914X-1000	606D-04B-SM-G10-L14-X	-	-	-	7	4
CCSO-914Y12-1090	606D-04B-SM-G10-L14-X	-	-	-	7	4
CCO-983/985	606D-04B-SM-G10-L14-X	-	-	-	7	4
CVCSO-914M3	606D-04B-SM-G10-L14-X	-	-	-	7	4
CVHD-965	606D-04B-SM-G10-L14-X	-	-	-	7	4
CCSS-945	606D-04B-SM-G10-L14-X	-	-	-	7	4
CVHD-931	606D-04B-SM-G10-L14-X	-	-	-	7	4
CCHD-950	606D-04B-SM-G10-L14-X	-	-	-	7	4
CCHD-957	606D-04B-SM-G10-L14-X	-	-	-	7	4
CCSO-914X	606D-04B-SM-G10-L14-X	-	-	-	7	4
CCHD-931	606D-04B-SM-G10-L14-X	-	-	-	7	4
CVCSO-914M3	606D-04B-SM-G10-L14-X	-	-	-	7	4
CVCSO-914-1000	606D-04B-SM-G10-L14-X	-	-	-	7	4
CVSS-945	606D-04B-SM-G10-L14-X	-	-	-	7	4
CVHD-950	606D-04B-SM-G10-L14-X	-	-	-	7	4
CVHD-930	606D-04B-SM-G10-L14-X	-	-	-	7	4
CVCSO-914	606D-04B-SM-G10-L14-X	-	-	-	7	4
CVCOT8BE	R300-0804-01T-XXX-R27-L14	01S	93S	.018	8	4
UM-1 LEADED CRYSTAL	CSP148-02-02-XXX-R27-L14	01S	93S	.018	9	4
CRMXX MODEL	CSP148-02-02-XXX-R27-L14	01S	93S	.018	9	4
CXOH20	C10-614-05-01-XXX-R27-L14	01S	93S	.018	10	4
CO27VH15DE-02-10.000	C10-1014-05-02-XXX-R27-L14	295V	439V	.030	11	4
CO27VS0FDE-02-10.000	C10-1014-05-02-XXX-R27-L14	295V	439V	.030	11	4
CO27VS12DE-02-10.000	C10-1014-05-02-XXX-R27-L14	295V	439V	.030	11	4
CYXX SERIES	CSP192-02-01-XXX-R27-L14	01S	93S	.018	12	5
CYSXX SERIES	CSP192-02-01-XXX-R27-L14	01S	93S	.018	12	5
CXOH/CXOHV	C10-314-04-01-XXX-R27-L14	01S	93S	.018	13	5
CXOS/CXOSV	C10-314-04-01-XXX-R27-L14	01S	93S	.018	13	5

**CRYSTEK CORPORATION** *Continued*

**Socket Terminal Details**

*Cross Section View Shown Units: in [mm]*

(FIG.1) CRYSTEK CORPORATION	ANDON PART NUMBER
	THRU-HOLE: N/A SURFACE MOUNT: 680-22SP-SM-G10-L14-X

CPLL66-1600-2200

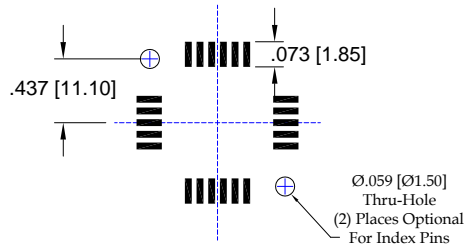
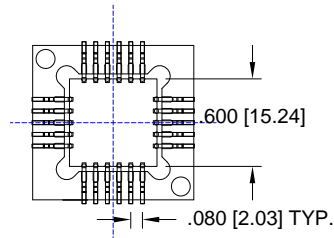

(FIG.2) CRYSTEK CORPORATION	ANDON PART NUMBER
	THRU-HOLE: N/A SURFACE MOUNT: 680-20SP-SM-G10-L14-X

CLL58PLL

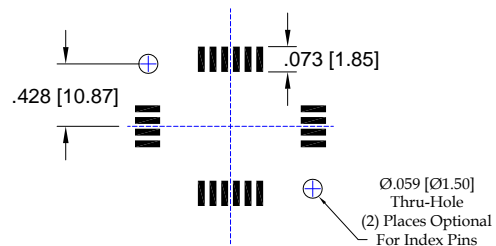
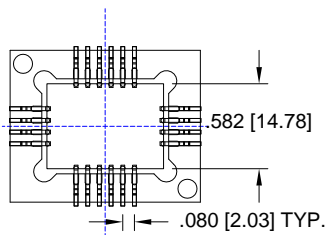

(FIG.3) CRYSTEK CORPORATION	ANDON PART NUMBER
	THRU-HOLE: N/A SURFACE MOUNT: 605-12A-SM-G10-L14-X

CVCO38

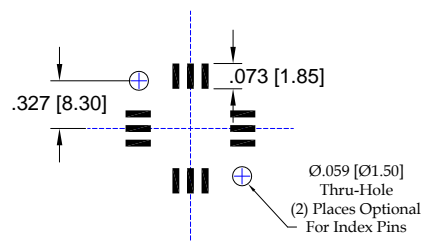
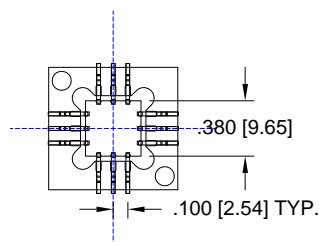

## CRYTEK CORPORATION *Continued*

### Socket Terminal Details

Cross Section View Shown Units: in [mm]

(FIG.4) CRYTEK CORPORATION	ANDON PART NUMBER
	THRU-HOLE: N/A SURFACE MOUNT: 605-16-SM-G10-L14-X

CVCO55  
CVCO45  
CVCO38  
CVCO33  
CVCO25  
CVCOT8  
CVC057P

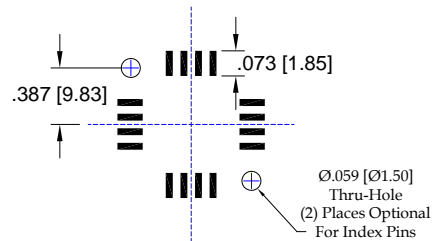
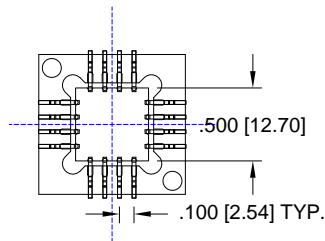

(FIG.5) CRYTEK CORPORATION	ANDON PART NUMBER
	THRU-HOLE: N/A SURFACE MOUNT: 612D-04-SM-G10-L14-X

CVCO45 SERIES

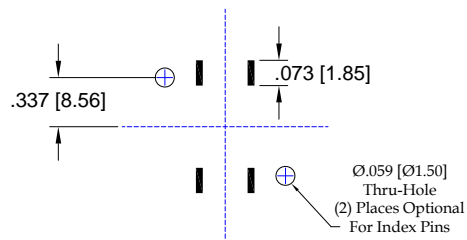
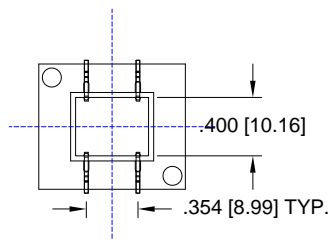

(FIG.6) CRYTEK CORPORATION	ANDON PART NUMBER
	THRU-HOLE: N/A SURFACE MOUNT: 605D-06B-SM-G10-L14-X

CVPD-034  
CVXO-18T  
CVXO-016T  
CCPD-034  
CCPD-023  
CCLD-023  
CVHD-037X  
CVPD-037X

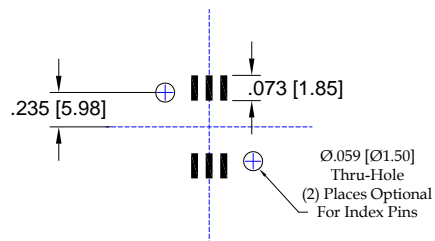
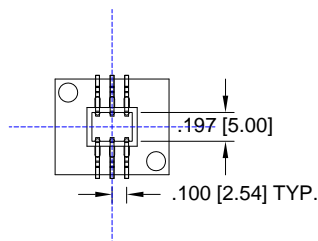

## CRYTEK CORPORATION *Continued*

### Socket Terminal Details

Cross Section View Shown Units: in [mm]

(FIG.7) CRYTEK CORPORATION	ANDON PART NUMBER
	THRU-HOLE: N/A SURFACE MOUNT: 606D-04B-SM-G10-L14-X

- CCSO-914X-245.760 CCHD-950
- CCSO-914X3-1000 CCHD-957
- CCSO-914X-1000 CCSO-914X
- CCSO-914Y12-1090 CCHD-931
- CCO-983/985 CVCSO-914M3
- CVCSO-914M3 CVCSO-914-1000
- CVHD-965 CVSS-945
- CCSS-945 CVHD-950
- CVHD-931 CVHD-930
- CVCSO-914 CVCSO-914

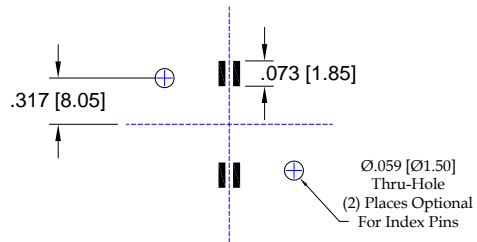
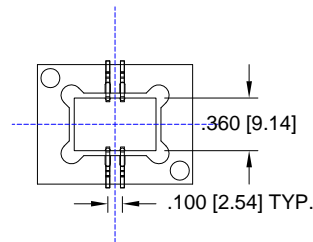

(FIG.8) CRYTEK CORPORATION	ANDON PART NUMBER
	THRU-HOLE: R300-0804-01T-01S-R27-L14 SURFACE MOUNT: R300-0804-01T-93S-R27-L14

CVCOT8BE

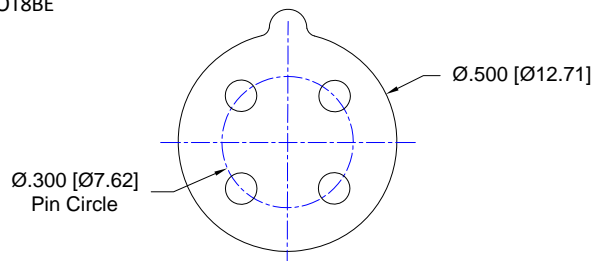

(FIG.9) CRYTEK CORPORATION	ANDON PART NUMBER
	THRU-HOLE: CSP148-02-02-01S-R27-L14 SURFACE MOUNT: CSP148-02-02-93S-R27-L14

UM-1 LEADED CRYSTAL  
CRMXX MODEL

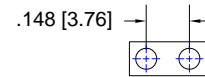

(FIG.10) CRYTEK CORPORATION	ANDON PART NUMBER
	THRU-HOLE: C10-614-05-01-01S-R27-L14 SURFACE MOUNT: C10-614-05-01-93S-R27-L14

CXOH20

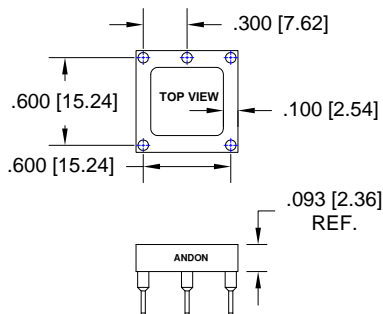

(FIG.11) CRYTEK CORPORATION	ANDON PART NUMBER
	THRU-HOLE: C10-1014-05-02-295V-R27-L14 SURFACE MOUNT: C10-1014-05-02-439V-R27-L14

CO27VH15DE-02-10.000  
CO27VS0FDE-02-10.000  
CO27VS12DE-02-10.000

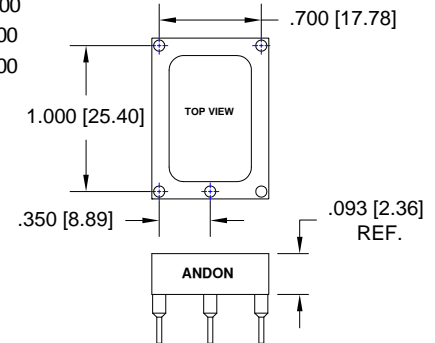

## CRYTEK CORPORATION *Continued*

### Socket Terminal Details

Cross Section View Shown Units: in [mm]

(FIG.12) CRYTEK CORPORATION	ANDON PART NUMBER
	THRU-HOLE: CSP192-02-01-01S-R27-L14 SURFACE MOUNT: CSP192-02-01-93S-R27-L14

(FIG.13) CRYTEK CORPORATION	ANDON PART NUMBER
	THRU-HOLE: C10-314-04-01-01S-R27-L14 SURFACE MOUNT: C10-314-04-01-93S-R27-L14

CYXX SERIES  
CYSXX SERIES

CXOH/CXOHV  
CXOS/CXOSV

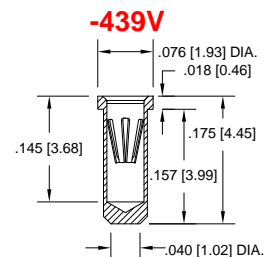
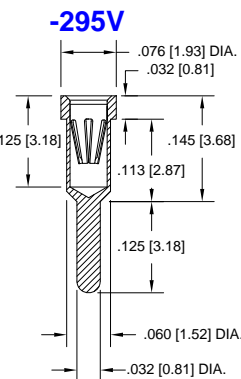
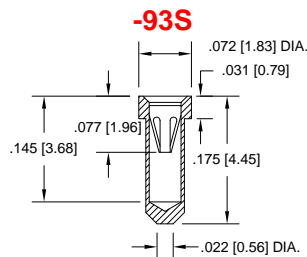
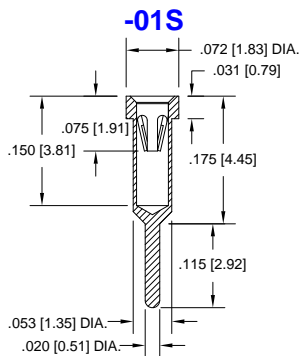
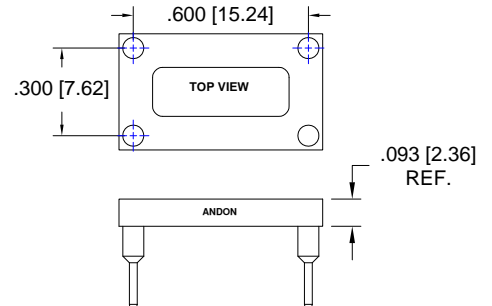
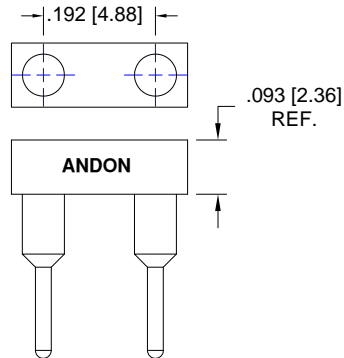

## Technical Information

### Material:

Insulator: Hi-Temp UL 94V-O  
Terminal: Brass, per ASTM-B16  
Contact: BeCu, Per ASTM-B194

### Plating: RoHS COMPLIANT

R15 TERMINAL: GOLD / CONTACT: GOLD

R17 TERMINAL: TIN / CONTACT: GOLD

OTHER PLATINGS AVAILABLE

Terminal Acceptance and Forces							
Thru Hole Terminals				Surface Mount Terminals			
Thru Hole Terminal	Accepts Pin Diameter	Insertion Force	Withdrawal Force	Surface Mount Terminal	Accepts Pin Diameter	Insertion Force	Withdrawal Force
-01S	Ø.018 [Ø0.46]	9.0 oz Avg.	2.0 oz Min	-93S	Ø.018 [Ø0.46]	9.0 oz Avg.	2.0 oz Min
-295V	Ø.030 [Ø0.76]	13.2 oz Max	3.5 oz Min	-439V	Ø.030 [Ø0.76]	13.2 oz Max	3.5 oz Min

### MOUNTING OPTIONS

