

CAL CRYSTAL LAB, INC./COMCLOCK, INC						
CAL CRYSTAL LAB, INC./COMCLOCK, INC Model Number	Andon Part Number Replace "XXX" with Terminal Type	Terminal Type		Pin Ø [in]	Figure Number	Page Number
		Thru-Hole	Surface Mount			
CCL-6S SERIES	CSP192-02-01-XXX-R27-L14	01S	93S	.018	10	3
CCL-6 SERES	CSP192-02-01-XXX-R27-L14	01S	93S	.018	10	3
CCL-10 SERIES	CSP148-02-01-XXX-R27-L14	400T4	414T4	.012	11	3
CM-F SERIES	C10-314-04-01-XXX-R27-L14	01S	93S	.018	1	1
CO-F	C10-314-04-01-XXX-R27-L14	01S	93S	.018	1	1
CX-F	C10-314-04-01-XXX-R27-L14	01S	93S	.018	1	1
CV-F	C10-314-04-01-XXX-R27-L14	01S	93S	.018	1	1
CW-F	C10-314-04-01-XXX-R27-L14	01S	93S	.018	1	1
CY-F	C10-314-04-01-XXX-R27-L14	01S	93S	.018	1	1
CZ-F	C10-314-04-01-XXX-R27-L14	01S	93S	.018	1	1
HA-F	C10-314-04-01-XXX-R27-L14	01S	93S	.018	1	1
HE-F	C10-314-04-01-XXX-R27-L14	01S	93S	.018	1	1
CM-H SERIES	C10-308-04-02-XXX-R27-L14	01S	93S	.018	2	1
CO-H	C10-308-04-02-XXX-R27-L14	01S	93S	.018	2	1
CX-H	C10-308-04-02-XXX-R27-L14	01S	93S	.018	2	1
CV-H	C10-308-04-02-XXX-R27-L14	01S	93S	.018	2	1
CW-H	C10-308-04-02-XXX-R27-L14	01S	93S	.018	2	1
CY-H	C10-308-04-02-XXX-R27-L14	01S	93S	.018	2	1
CZ-H	C10-308-04-02-XXX-R27-L14	01S	93S	.018	2	1
HA-H	C10-308-04-02-XXX-R27-L14	01S	93S	.018	2	1
HE-H	C10-308-04-02-XXX-R27-L14	01S	93S	.018	2	1
CCL-11 SERIES	R043-002-02-01-XXX-R27-L14	400T4	414T4	.012	7	2
CCL-1/HC-4B	C486-002-02-02-XXX-R27-L14	436P55	440P55	.060	5	2
CCL-3/HC-51	C486-002-02-02-XXX-R27-L14	295V	439V	.030	8	2
CCL-6/HC-49	CSP192-02-01-XXX-R27-L14	01S	93S	.018	10	3
CCL-7/HC-50	CSP192-02-02-XXX-R27-L14	433E	285E	.040	6	2
CCL-8/UM-2	C20-002-02-02-XXX-R27-L14	01S	93S	.018	4	2
CI/CS SERIES	606D-04A-SM-G10-L14-1	-	-	-	13	3
CI/CS SERIES	605D-06B-SM-G10-L14-1	-	-	-	12	3
CA & CL/CE SERIES	C10-314-04-01-XXX-R27-L14	01S	93S	.018	1	1
CG/ CK SERIES	C10-614-05-01-XXX-R27-L14	01S	93S	.018	9	3
CCL-10/UM1	CSP175-02-01-XXX-R27-L14	01S	93S	.018	3	2
FULL SIZE 14-PIN DIP	C10-314-04-01-XXX-R27-L14	01S	93S	.018	1	1
HALF SIZE 8-PIN DIP	C10-308-04-02-XXX-R27-L14	01S	93S	.018	2	2
CCL-13	CSP192-02-02-XXX-R27-L14	433E	285E	.040	6	2
HC-42/U	CSP192-02-02-XXX-R27-L14	433E	285E	.040	6	2
CCL-14	CSP192-02-01-XXX-R27-L14	01S	93S	.018	10	3
HC-43/U	CSP192-02-01-XXX-R27-L14	01S	93S	.018	10	3

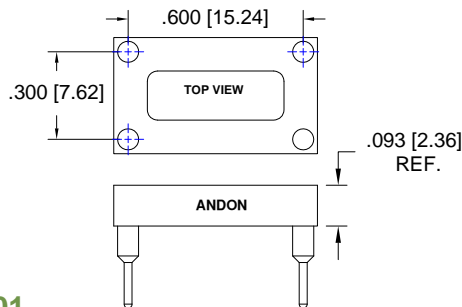

Fig. 01

Thru-Hole: C10-314-04-01-01S-R27-L14
Surface Mount: C10-314-04-01-93S-R27-L14

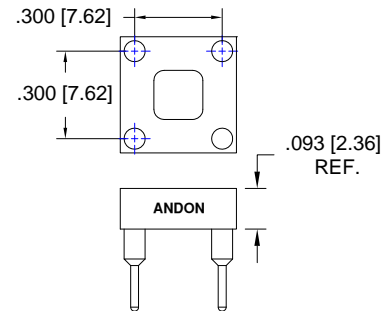

Fig. 02

Thru-Hole: C10-308-04-02-01S-R27-L14
Surface Mount: C10-308-04-02-93S-R27-L14

CAL CRYSTAL LAB, INC. / COMCLOCK, INC Continued

Socket Terminal Details
Cross Section View Shown Units: in [mm]

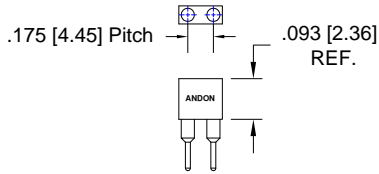

Fig. 03
Thru-Hole: CSP175-02-01-01S-R27-L14
Surface Mount: CSP175-02-01-93S-R27-L14

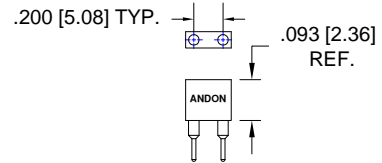

Fig. 04
Thru-Hole: C20-002-02-02-01S-R27-L14
Surface Mount: C20-002-02-02-93S-R27-L14

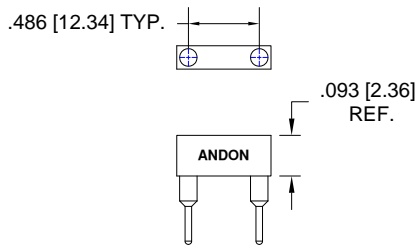

Fig. 05
Thru-Hole: C486-002-02-02-436P55-R27-L14
Surface Mount: C486-002-02-02-440P55-R27-L14

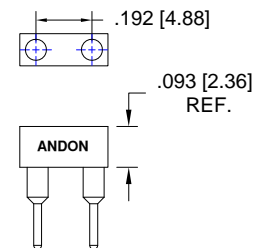

Fig. 06
Thru-Hole: CSP192-02-02-433E-R27-L14
Surface Mount: CSP192-02-02-285E-R27-L14

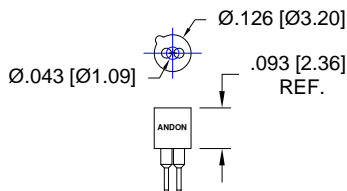

Fig. 07
Thru-Hole: R043-002-02-01-400T4-R27-L14
Surface Mount: R043-002-02-01-414T4-R27-L14

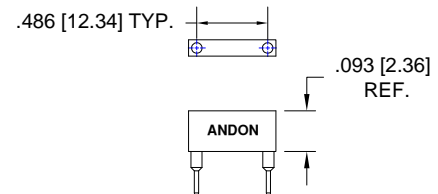

Fig. 08
Thru-Hole: C486-002-02-02-295V-R27-L14
Surface Mount: C486-002-02-02-439V-R27-L14

CAL CRYSTAL LAB, INC. / COMCLOK, INC Continued

Socket Terminal Details
Cross Section View Shown Units: in [mm]

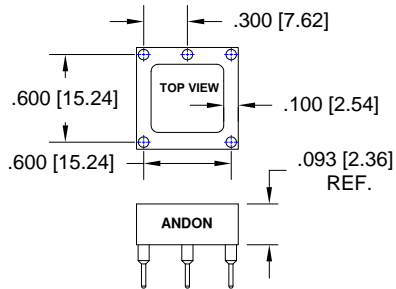

Fig. 09
Thru-Hole: C10-614-05-01-01S-R27-L14
Surface Mount: C10-614-05-01-93S-R27-L14

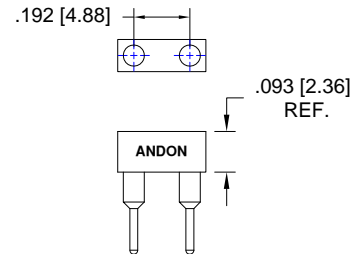

Fig. 10
Thru-Hole: CSP192-02-01-01S-R27-L14
Surface Mount: CSP192-02-01-93S-R27-L14

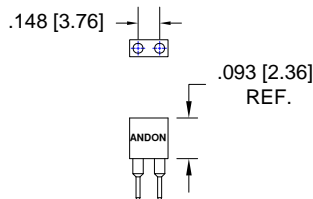

Fig. 11
Thru-Hole: CSP148-02-01-400T4-R27-L14
Surface Mount: CSP148-02-01-414T4-R27-L14

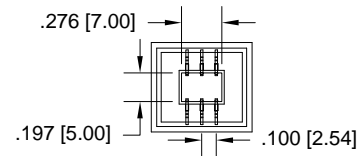

Fig. 12
Thru-Hole: N/A
Surface Mount: 605D-06B-SM-G10-L14-X

Replace "-X" with "-1" for index pins or "-0" for none

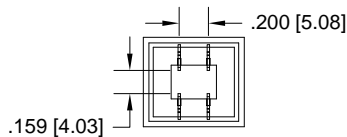
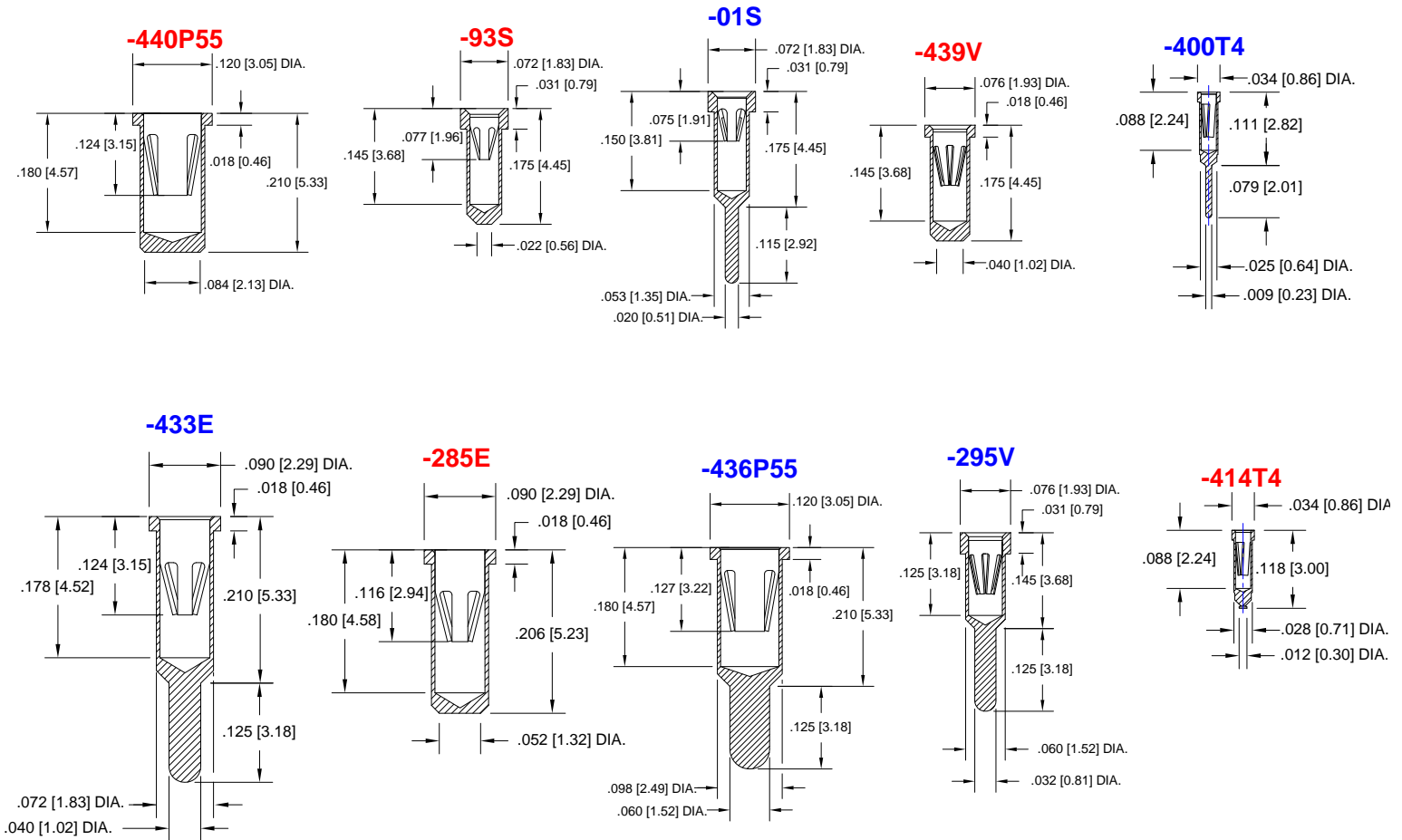

Fig. 13
Thru-Hole: N/A
Surface Mount: 606D-04A-SM-G10-L14-X

Replace "-X" with "-1" for index pins or "-0" for none

CAL CRYSTAL LAB, INC. / COMCLOCK, INC *Continued*

Socket Terminal Details Cross Section View Shown Units: in [mm]



Technical Information

Material:

Insulator: Hi-Temp UL 94V-O
Terminal: Brass, per ASTM-B16
Contact: BeCu, Per ASTM-B194

Plating: RoHS COMPLIANT

R15 TERMINAL: GOLD / CONTACT: GOLD

R17 TERMINAL: TIN / CONTACT: GOLD

OTHER PLATINGS AVAILABLE

Terminal Acceptance and Forces							
Thru Hole Terminals				Surface Mount Terminals			
Thru Hole Terminal	Accepts Pin Diameter	Insertion Force	Withdrawal Force	Surface Mount Terminal	Accepts Pin Diameter	Insertion Force	Withdrawal Force
-01S	Ø.018 [Ø0.46]	9.0 oz Avg.	2.0 oz Min	-93S	Ø.018 [Ø0.46]	9.0 oz Avg.	2.0 oz Min
-400T4	Ø.012 [Ø1.52]	1.1 oz Max	0.3 oz Min	-414T4	Ø.012 [Ø1.52]	1.1 oz Max	0.3 oz Min
-436P55	Ø.060 [Ø1.52]	15.5 oz Max	0.3 oz Min	-440P55	Ø.012 [Ø1.52]	1.1 oz Max	0.3 oz Min
-295V	Ø.030 [Ø0.76]	13.2 oz Max	3.5 oz Min	-439V	Ø.012 [Ø1.52]	1.1 oz Max	0.3 oz Min
-433E	Ø.012 [Ø1.52]	15.5 oz Max	2.1 oz Min	-285E	Ø.012 [Ø1.52]	1.1 oz Max	0.3 oz Min

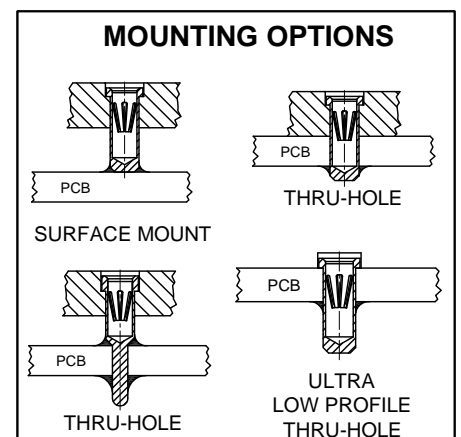

©Copyright 2015 Andon Electronics Corporation. All Rights Reserved. This material is protected under US and other copyrights and may not be copied, sold, or redistributed in any form without written permission of Andon Electronics Corporation. Copyrights and trademarks are property of their respective companies. We reserve the right to change specifications without notice. Andon makes no warranty, expressed or implied, as to the suitability of the sockets for the intended purpose.

"ANDON PROPRIETARY INFORMATION"

RoHS Compliant

www.andonelectronics.com or www.andonelect.com
Phone 401-333-0388 Fax 401-333-0287

ANDON ELECTRONICS CORPORATION
4 Court Drive, Lincoln RI 02865, United States of America